

L908/L909/L901
L809/L801

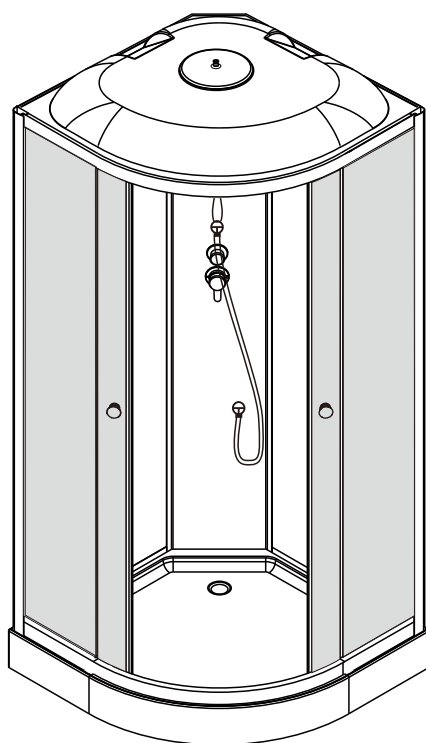

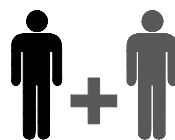

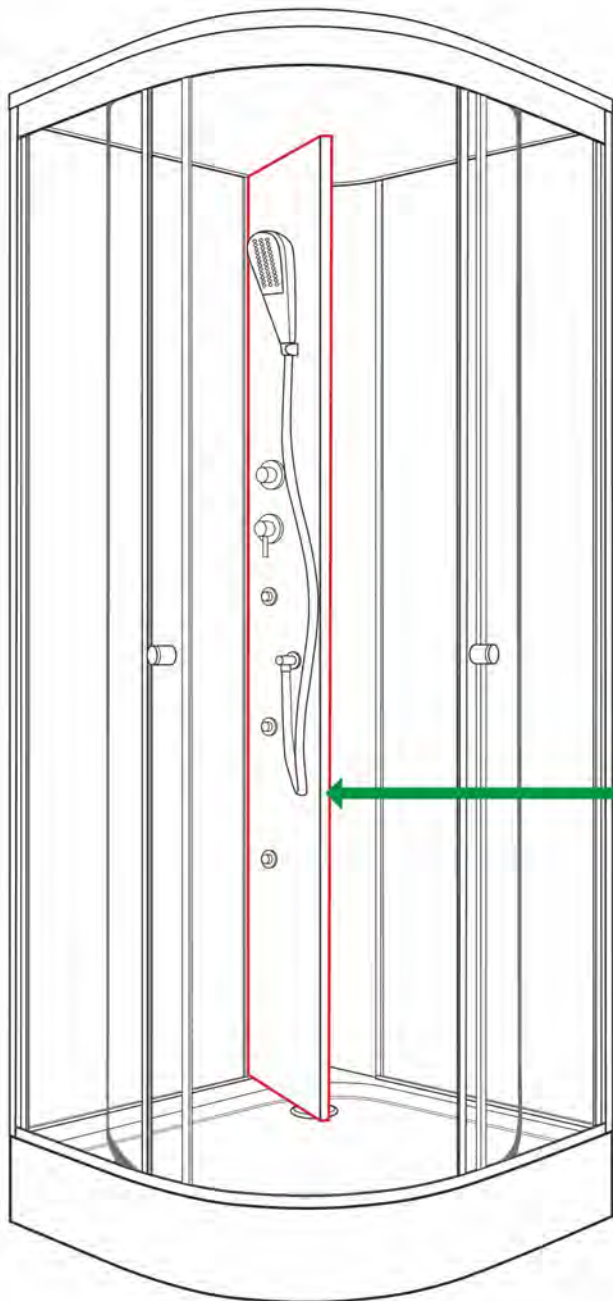

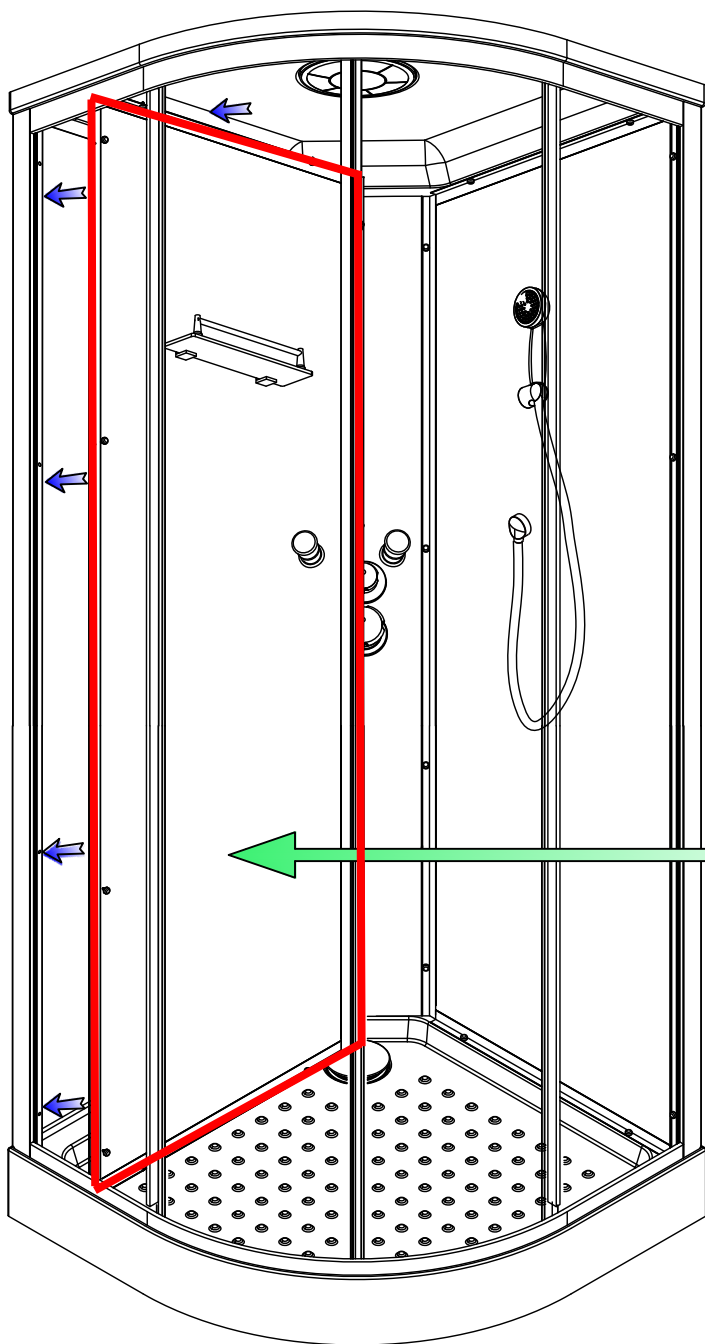



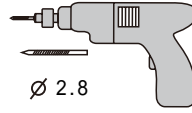

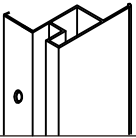

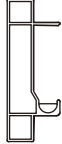



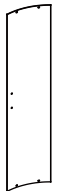



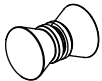
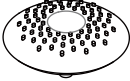

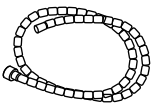
Сборка
изнутри



Сборка
изнутри

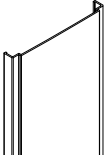

 <p>A1</p>	 <p>A2</p>	 <p>A3</p>	 <p>A4</p>	 <p>A5</p>
 <p>A6 X4</p>	 <p>A7</p>	 <p>A8</p>	 <p>A9 X4</p>	 <p>A10</p>
 <p>A11</p>	 <p>A12</p>	 <p>A13</p>	 <p>A14</p>	 <p>A15</p>
 <p>A16</p>	<p>M4X25 =2</p>  <p>A17</p>	 <p>A18</p>	 <p>A19</p>	 <p>A20 X4</p>
 <p>=24</p> <p>A21</p>	 <p>X1</p> <p>A22</p>	 <p>ST4X50=8 ST4X12=44</p> <p>A23</p>	 <p>X2</p>	

